

Cat # K3679 series 3 pin Quick Lock Power Plug and Socket

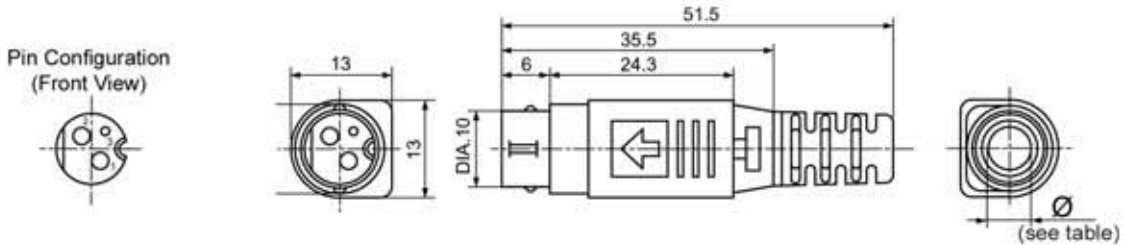

Cat #	Maximum Cable Ø
K3679-335	3.5mm
K3679-350	5.0mm
K3679-355	5.5mm
K3679-365	6.5mm
K3679-370	7.0mm

Pin Configuration (Front View)

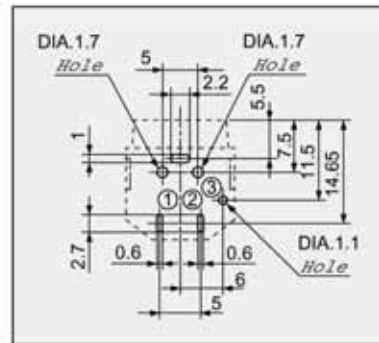
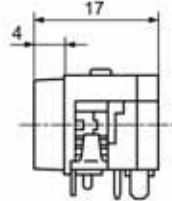
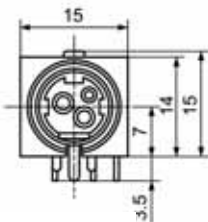
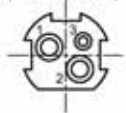

PCB Footprint

Cat #	Description
K3716	3 pin Socket

Rating	Pins 1 & 2	7.5A 20V DC maximum
	Pin 3	1.0A 20V DC maximum
Insulation Resistance	50MΩ min @ 250V DC	
Insulation Material	UL-approved material (94 V-0)	
Dielectric Strength	250V AC / 1 minute	
Contact Resistance	Pins 1 & 2	30MΩ maximum
	Pin 3	50MΩ maximum
Insertion Force	49N maximum	
Withdrawal Force	.98N to 49N	
Conductor Size	Pins 1 & 2	18AWG maximum
	Pin 3	24AWG maximum
Wire to Pin Connections	Soldered	

Cat # K3679 series 4 pin Quick Lock Power Plug and Socket

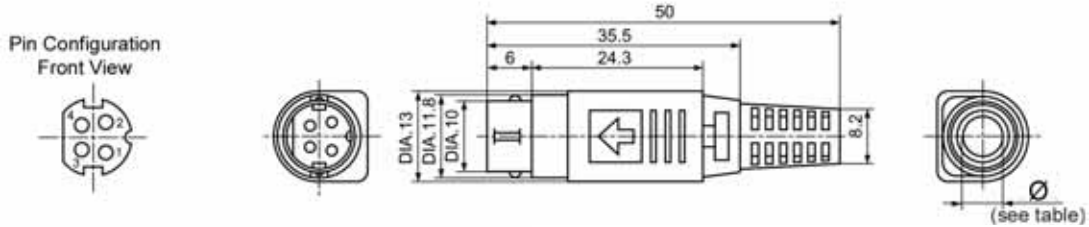

Cat #	Maximum Cable Ø
K3679-435	3.5mm
K3679-450	5.0mm
K3679-455	5.5mm
K3679-465	6.5mm
K3679-470	7.0mm

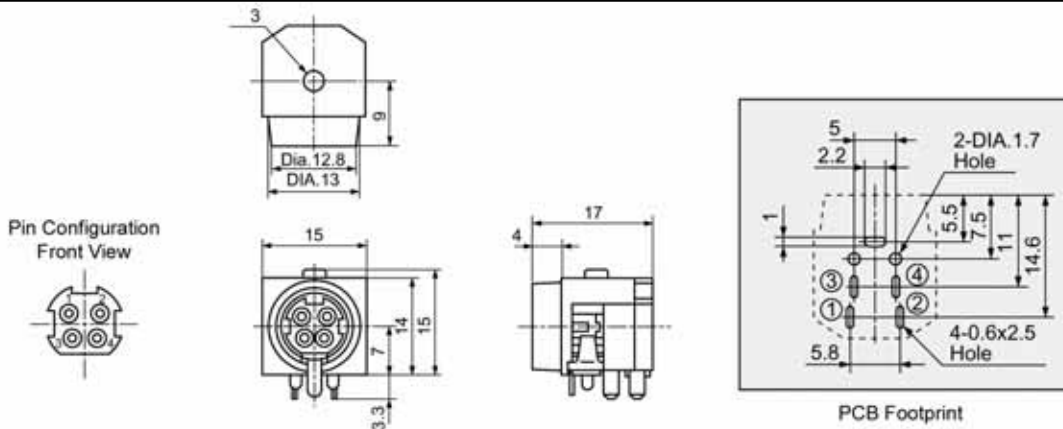

Cat #	Description
K3717	4 Pin Socket

Rating	7.5A 20V DC max
Insulation Resistance	50MΩ min @ 250V DC
Insulation Material	UL-approved material (94 V-0)
Dielectric Strength	250V AC / 1 minute
Contact Resistance	30MΩ.max
Insertion Force	49N max
Withdrawal Force	.98N to 49N
Conductor Size	18AWG max
Wire to Pin Connections	Soldered